

Mounting Kit STABICAN-200t for CA40X with rated load from 100 ... 200 t

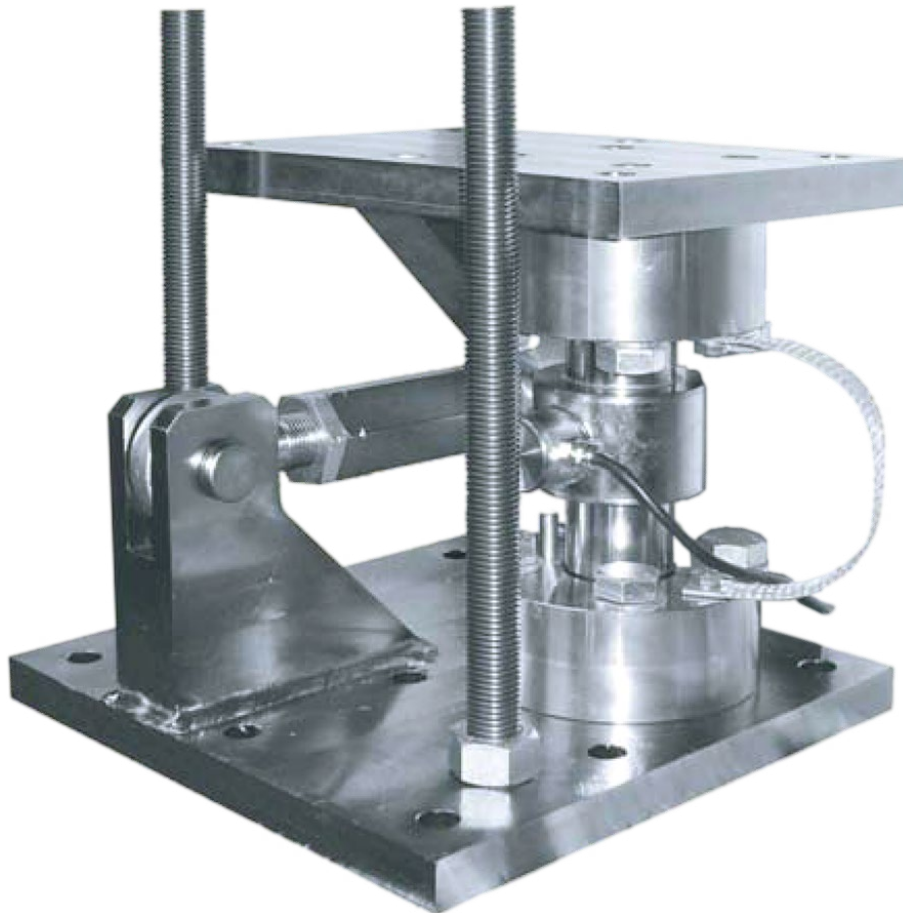

Load cell and plates sold separately

Performance Features

- Designed for high capacity tank or silo weighing
- Zinc plated or stainless steel construction
- Integrated stabilization rods
- Lift-off prevention system
- Compact design for easy installation
- Spacings set up in factory

Application

- Food industry
- Mining industry
- Chemical/ pharmaceutical industry
- Waste management/ recycling
- Packaging technology



Dimensions in mm

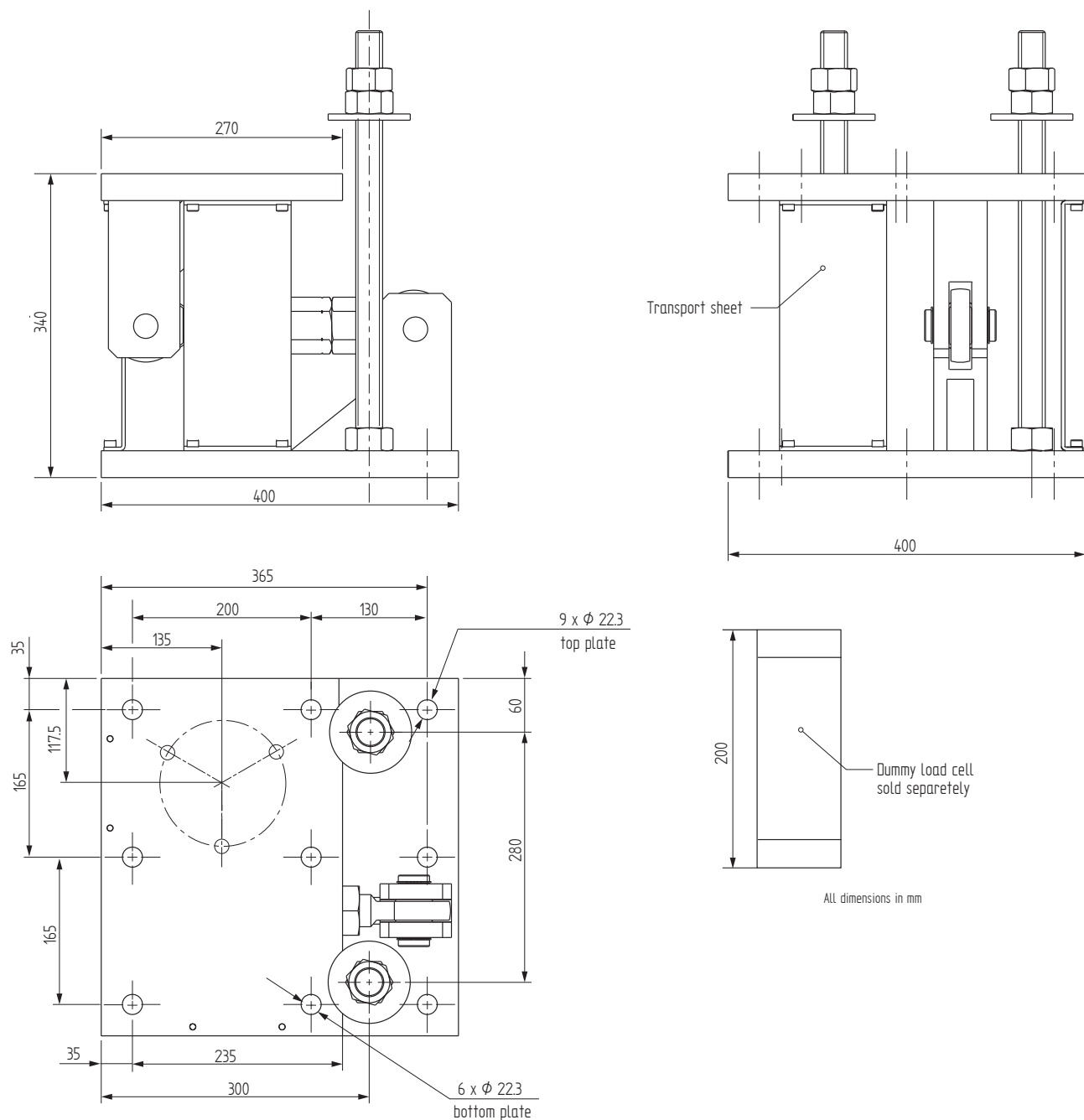

Technical Data

Load Cell CA40X	STABICAN 200 t
Maximum horizontal force (t)	20 t
Maximum lift-off force (t)	23 t

Article-No.	Version	Rated load [t]
108589	STABICAN-200t	100...200

Accessories

Mounting kit for CA40X

Article-No.	Description	Material	
113288	Plates kit	Galvanized steel	
105223	CA40X Dummy load cell	Aluminum	See picture on page 2

Application examples

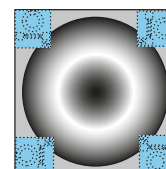
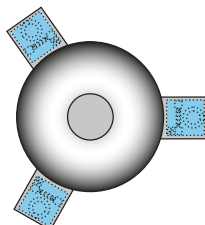
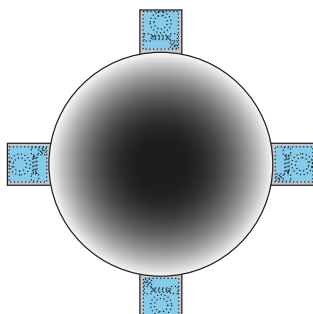
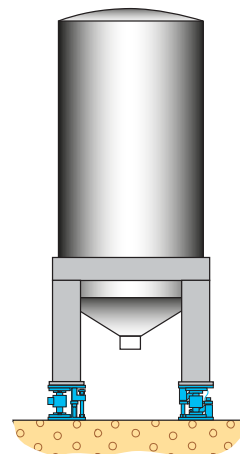
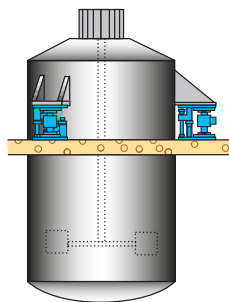
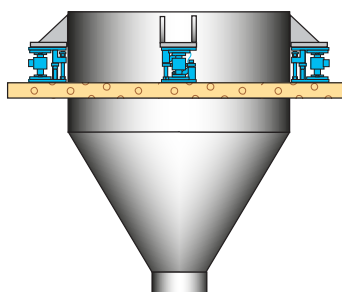

Further suitable accessories you can find on our homepage under:
<https://www.lorenz-messtechnik.de/english/products/load-cells.php>